

4 faces suspendu

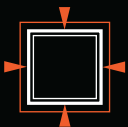

	dimensions en mm / afmetingen in cm				poids gewicht	performances / prestaties		
	a x b x c	h x i	j	Ø		rendement en % rendement in %	puissance en kW geschat in kW	Taux de CO en % CO in %
700	1591 x 700 x 700	606 x 606	550	250	370	78	20	0,19
800	1945 x 800 x 800	706 x 706	590	250	390	78	20	0,19

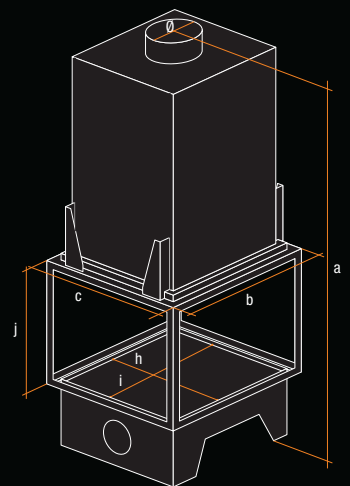

700

800

